

DATI 1400

Identification stamp with fast-change system Ø 2,6 – 16 mm with height adjustment, short version, with fastening thread

DATI®-DESCRIPTION



- Sleeve with identifier
- Adjustable insert with an indicator arrow.
The recessed indicator arrow is used as a screw slot for adjustment and to change the insert
- Fastening thread
- Compression spring for the infinite locking of the adjustable insert
- Material for sleeve and adjustable insert:
1.4034, hardened HRC 56 ± 2 stainless
- Inscription laterally reversed

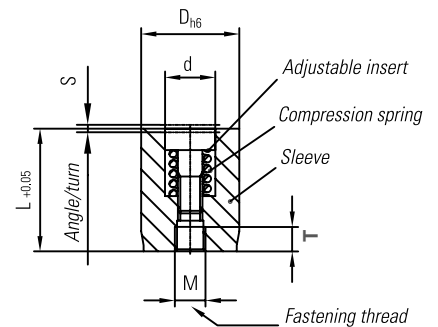

Installation

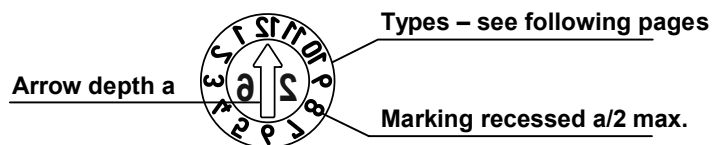
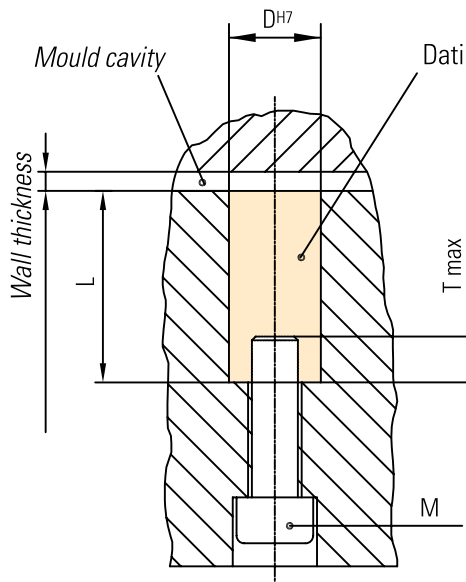

Dimension table in mm						
D	d	L	M	T	a	S
2,6	1,4	7	1,6	2	0,20	0,20
2,8	1,4	7	1,6	2	0,20	0,20
3	1,5	7	2	2	0,20	0,20
3,5	1,8	8	2	2	0,20	0,25
4	2,1	8	2	2	0,30	0,25
5	3,1	12	3	3	0,40	0,20
6	3,1	12	3	3	0,40	0,20
8	4,4	14	4	3	0,40	0,20
10	5,2	16	4	3	0,40	0,25
12	6,2	20	5	4	0,60	0,35
16	8,2	20	5	4	0,60	0,35

FAST CHANGING SYSTEM

			<p>At the end of each year, the adjustable insert with year is changed in a matter of seconds by removing and screwing it in.</p> <ul style="list-style-type: none"> - Stop production, open mould - Change adjustable insert, set date - Continue production - Check setting on moulded part
<p>To screw in adjustable insert:</p> <ul style="list-style-type: none"> • Turn clockwise • Adjust height according to visual estimate 	<p>To turn adjustable insert:</p> <ul style="list-style-type: none"> • Turn clockwise or counter-clockwise • Check height adjustment 	<p>To change adjustable insert:</p> <ul style="list-style-type: none"> • Turn continuously counter-clockwise • The adjustable insert will raise • Remove adjustable insert 	

DATI 1400

Identification stamp with fast-change system Ø 2,6 – 16 mm with height adjustment, short version, with fastening thread

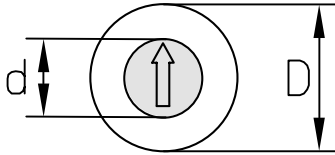

Dimension table in mm												
D	2,6	2,8	3	3,5	4	5	6	8	10	12	16	mm
d	1,4	1,4	1,5	1,8	2,1	3,1	3,1	4,4	5,2	6,2	8,2	mm

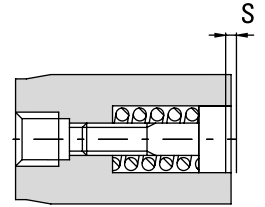







Type	A	B	C	CC
Indicator				
D	Order no.	Order no.	Order no.	Order no.
2,6	A/1402,6/Jahr(Year)	B/1402,6/00	C/1402,6/Jahr(Year)+5	CC/1402,6/Jahr(Year)+11
2,8	A/1402,8/Jahr(Year)	B/1402,8/00	C/1402,8/Jahr(Year)+5	CC/1402,8/Jahr(Year)+11
3	A/1403/Jahr(Year)	B/1403/00	C/1403/Jahr(Year)+5	CC/1403/Jahr(Year)+11
3,5	A/1403,5/Jahr(Year)	B/1403,5/00	C/1403,5/Jahr(Year)+5	CC/1403,5/Jahr(Year)+11
4	A/1404/Jahr(Year)	B/1404/00	C/1404/Jahr(Year)+5	CC/1404/Jahr(Year)+11
5	A/1405/Jahr(Year)	B/1405/00	C/1405/Jahr(Year)+5	CC/1405/Jahr(Year)+11
6	A/1406/Jahr(Year)	B/1406/00	C/1406/Jahr(Year)+5	CC/1406/Jahr(Year)+11
8	A/1408/Jahr(Year)	B/1408/00	C/1408/Jahr(Year)+5	CC/1408/Jahr(Year)+11
10	A/1410/Jahr(Year)	B/1410/00	C/1410/Jahr(Year)+5	CC/1410/Jahr(Year)+11
12	A/1412/Jahr(Year)	B/1412/00	C/1412/Jahr(Year)+5	CC/1412/Jahr(Year)+11
16	A/1416/Jahr(Year)	B/1416/00	C/1416/Jahr(Year)+5	CC/1416/Jahr(Year)+11

Type	D + E	H + I	L + E	J
Indicator				
D	Order no.	Order no.	Order no.	Order no.
2,6	D+E/1402,6/Jahr(Year)	H+I/1402,6/00	L+E/1402,6/Jahr(Year)	J/1302,6/00
2,8	D+E/1402,8/Jahr(Year)	H+I/1402,8/00	L+E/1402,8/Jahr(Year)	J/1302,8/00
3	D+E/1403/Jahr(Year)	H+I/1403/00	L+E/1403/Jahr(Year)	J/1303/00
3,5	D+E/1403,5/Jahr(Year)	H+I/1403,5/00	L+E/1403,5/Jahr(Year)	J/1303,5/00
4	D+E/1404/Jahr(Year)	H+I/1404/00	L+E/1404/Jahr(Year)	J/1304/00
5	D+E/1405/Jahr(Year)	H+I/1405/00	L+E/1405/Jahr(Year)	J/1305/00
6	D+E/1406/Jahr(Year)	H+I/1406/00	L+E/1406/Jahr(Year)	J/1306/00
8	D+E/1408/Jahr(Year)	H+I/1408/00	L+E/1408/Jahr(Year)	J/1308/00
10	D+E/1410/Jahr(Year)	H+I/1410/00	L+E/1410/Jahr(Year)	J/1310/00
12	D+E/1412/Jahr(Year)	H+I/1412/00	L+E/1412/Jahr(Year)	J/1312/00
16	D+E/1416/Jahr(Year)	H+I/1416/00	L+E/1416/Jahr(Year)	J/1316/00

DATI 1400

Identification stamp with fast-change system Ø 2,6 – 16 mm with height adjustment, short version, with fastening thread

Type	K	M	N	R
Indicator				
	Quarter + year (e.g. 1st quarter 26)	Identifier letters A – M (type M)	Identifier letters N – Z (type N)	Identification according to customers preference e.g. material identification
D	Order no.	Order no.	Order no.	Order no.
2,6	K/1402,6/Jahr(Year)	M/1402,6/00	N/1402,6/00	R/1402,6/Zeichen(Symbol)
2,8	K/1402,8/Jahr(Year)	M/1402,8/00	N/1402,8/00	R/1402,8/Zeichen(Symbol)
3	K/1403/Jahr(Year)	M/1403/00	N/1403/00	R/1403/Zeichen(Symbol)
3,5	K/1403,5/Jahr(Year)	M/1403,5/00	N/1403,5/00	R/1403,5/Zeichen(Symbol)
4	K/1404/Jahr(Year)	M/1404/00	N/1404/00	R/1404/Zeichen(Symbol)
5	K/1405/Jahr(Year)	M/1405/00	N/1405/00	R/1405/Zeichen(Symbol)
6	K/1406/Jahr(Year)	M/1406/00	N/1406/00	R/1406/Zeichen(Symbol)
8	K/1408/Jahr(Year)	M/1408/00	N/1408/00	R/1408/Zeichen(Symbol)
10	K/1410/Jahr(Year)	M/1410/00	N/1410/00	R/1410/Zeichen(Symbol)
12	K/1412/Jahr(Year)	M/1412/00	N/1412/00	R/1412/Zeichen(Symbol)
16	K/1416/Jahr(Year)	M/1416/00	N/1416/00	R/1416/Zeichen(Symbol)

Type	T	WT	Z
Indicator			
	Days 1 – 31	Weekdays 1 – 7	without markings
D	Order no.	Order no.	Order no.
2,6	-	WT/1401,8/00	Z/1402,6/00
2,8	-	WT/1402,8/00	Z/1402,8/00
3	-	WT/1403/00	Z/1403/00
3,5	T/1403,5/00	WT/1403,5/00	Z/1403,5/00
4	T/1404/00	WT/1404/00	Z/1404/00
5	T/1405/00	WT/1405/00	Z/1405/00
6	T/1406/00	WT/1406/00	Z/1406/00
8	T/1408/00	WT/1408/00	Z/1408/00
10	T/1410/00	WT/1410/00	Z/1410/00
12	T/1412/00	WT/1412/00	Z/1412/00
16	T/1416/00	WT/1416/00	Z/1416/00

DATI 1400

Adjustable inserts for DATI 1400 / 1300 / 1800

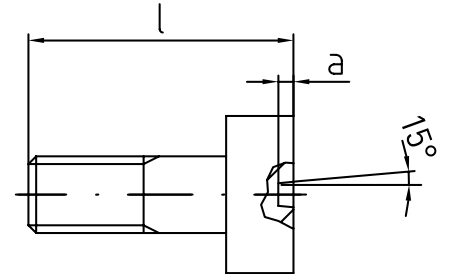
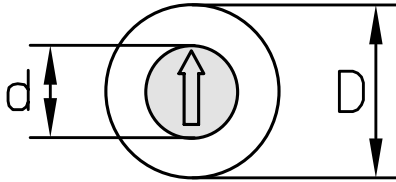

Dimension table in mm												
D	2,6	2,8	3	3,5	4	5	6	8	10	12	16	mm
d	1,4	1,4	1,5	1,8	2,1	3,1	3,1	4,4	5,2	6,2	8,2	mm
l	3,9	3,9	3,9	4,8	4,8	7,8	7,8	9,8	11,8	13,8	13,8	mm
a	0,2	0,2	0,2	0,2	0,3	0,4	0,4	0,4	0,4	0,6	0,6	mm

Material:
1.4034, hardened HRC 56 ± 2 stainless

Adjustable inserts for DATI 1400

Type	F	G	O
Indicator	Adjustable inserts with arrow + year	Adjustable inserts with arrow without year	Adjustable inserts according to customer preference with numbers and / or letters
D	Order no.	Order no.	Order no.
2,6	F/1402,6/Jahr(Year)	G/1402,6/00	O/1402,6/Zeichen(Symbol)
2,8	F/1402,8/Jahr(Year)	G/1402,8/00	O/1402,8/Zeichen(Symbol)
3	F/1403/Jahr(Year)	G/1403/00	O/1403/Zeichen(Symbol)
3,5	F/1403,5/Jahr(Year)	G/1403,5/00	O/1403,5/Zeichen(Symbol)
4	F/1404/Jahr(Year)	G/1404/00	O/1404/Zeichen(Symbol)
5	F/1405/Jahr(Year)	G/1405/00	O/1405/Zeichen(Symbol)
6	F/1406/Jahr(Year)	G/1406/00	O/1406/Zeichen(Symbol)
8	F/1408/Jahr(Year)	G/1408/00	O/1408/Zeichen(Symbol)
10	F/1410/Jahr(Year)	G/1410/00	O/1410/Zeichen(Symbol)
12	F/1412/Jahr(Year)	G/1412/00	O/1412/Zeichen(Symbol)
16	F/1416/Jahr(Year)	G/1316/00	O/1416/Zeichen(Symbol)

