

MP SERIES

MP 500



Ordering-Example:

Special Sizes Available On Request.



* F_{1i} =
Isothermal
end force
at 100% Cu

** F_{1p} =
Polytropic
end force
at 100% Cu

ACTIVE
SAFETY



OSAS



USAS

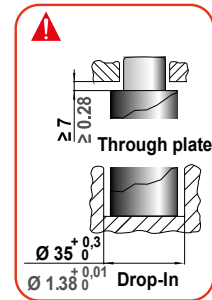
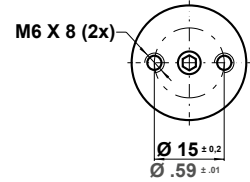
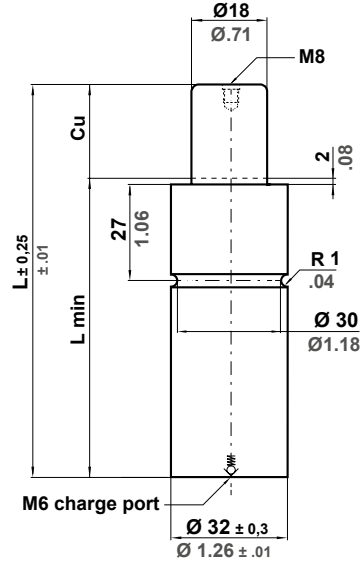

		0 - 80 °C 32 - 176 °F	ΔP ± 0.33 %/°C	P max 197 bar 2857 psi	P min 20 bar 290 psi	S 2.54 cm ² 0.394 in ²	SPM ~ 40 - 80 (at 20°C)	Max Speed 1.6 m/s 62.9 in/s	Maintenance kit Disposable
--	--	--------------------------	---------------------------	-------------------------------------	-----------------------------------	---	--------------------------------------	--	--------------------------------------

CODE	Cu		L		L min		F0 Initial force		F1i End force *		F1p End force **		V0		PED 2014/68/EU		
	mm	inch	mm	inch	mm	inch	daN	lb	daN	lb	daN	lb	cm ³	in ³	~Kg	~lb	
MP 500 - 010 - A	10	0.39	75	2.95	65	2.56	500	1124	714	1605	798	798	10,7	0.65	0,29	0.64	✓
MP 500 - 015 - A	15	0.59	85	3.35	70	2.76	± 5% 197 bar 2857 psi +20 °C +68 °F		770	1731	873	873	13,6	1.01	0,31	0.68	✓
MP 500 - 020 - A	20	0.79	95	3.74	75	2.95			809	1819	928	928	16,5	1.01	0,33	0.73	✓
MP 500 - 025 - A	25	0.98	105	4.13	80	3.15			839	1886	970	970	19,5	1.19	0,34	0.75	✓
MP 500 - 032 - A	32	1.26	120	4.72	88	3.46			859	1931	997	997	24,1	1.47	0,37	0.82	✓
MP 500 - 038 - A	38	1.50	135	5.31	97	3.82			849	1909	984	984	29,1	1.78	0,40	0.88	✓
MP 500 - 045 - A	45	1.77	150	5.91	105	4.13			862	1938	1002	1002	33,6	2.05	0,43	0.95	✓
MP 500 - 050 - A	50	1.97	160	6.30	110	4.33			875	1967	1020	1020	36,6	2.23	0,45	0.99	✓
MP 500 - 056 - A	56	2.20	175	6.89	119	4.69			866	1947	1008	1008	41,6	2.54	0,48	1.06	✓
MP 500 - 063 - A	63	2.48	195	7.68	132	5.20			844	1947	977	977	48,6	2.96	0,52	1.15	✓
MP 500 - 080 - A	80	3.15	230	9.06	150	5.91			869	1954	1012	1012	59,1	3.61	0,59	1.30	✓

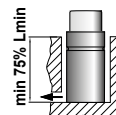

Drop-In

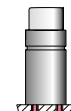

Bottom mount
FBE 32

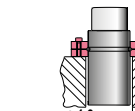

FCD 32 - FC 32
FCQC 32

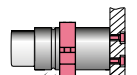

FSA 32 - FSD 32