



Square Interlocks

KZ Z50



KZZ50-0

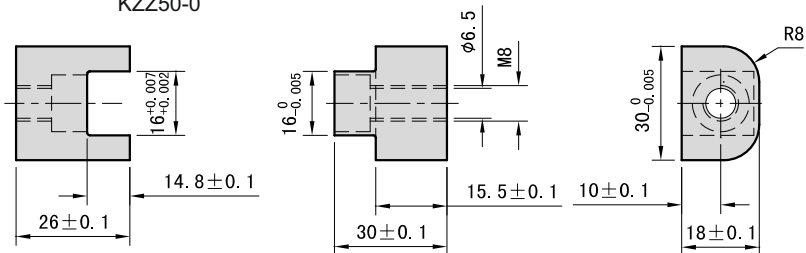

KZZ50-1

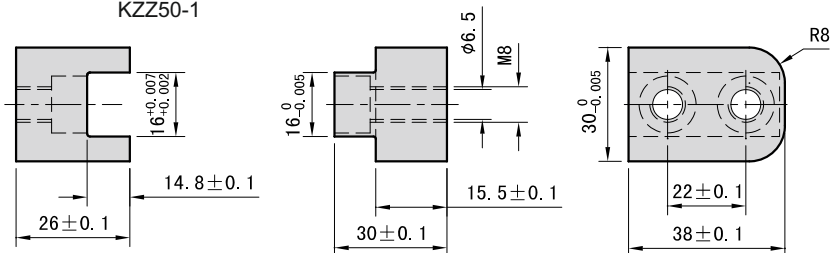

Installation Diagram:

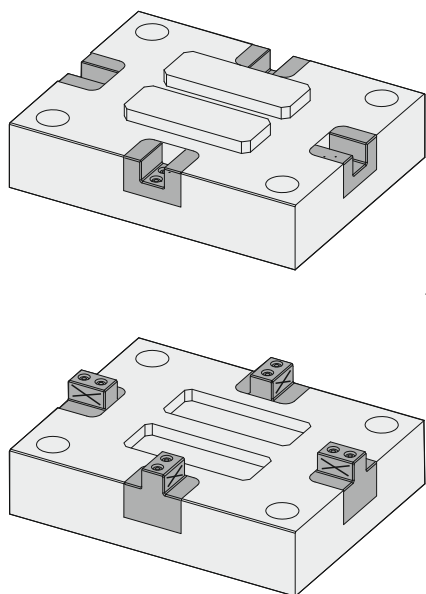

KZZ50-02

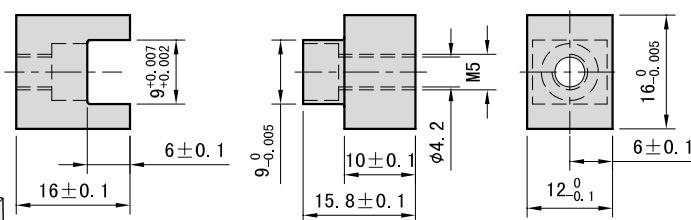

KZZ50-05

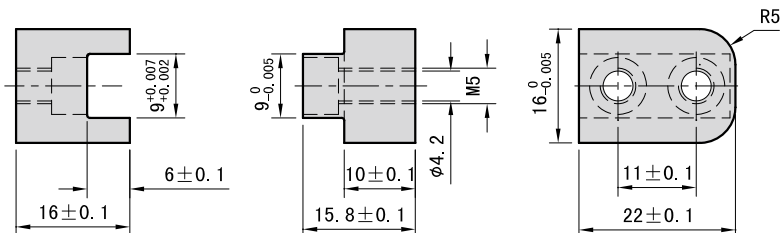

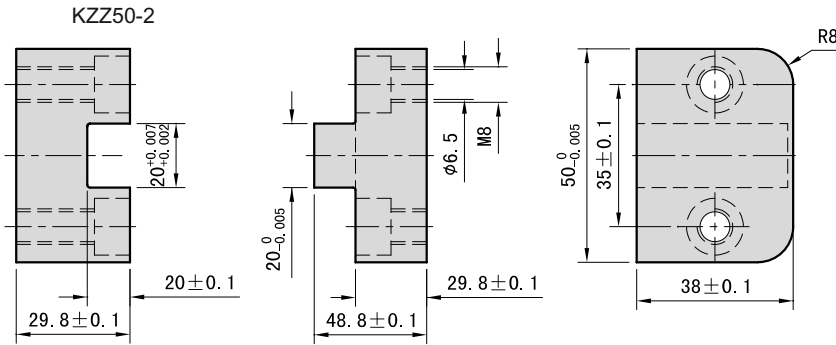

DIN
Square Interlocks

KZ Z50

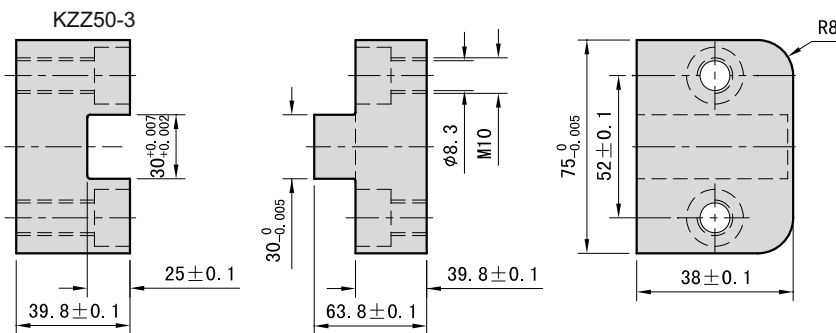

Installation Diagram:

